

Technische fiche :

MI 70 D ST5



Technical characteristics		Metrisch	
1.1	Manufacturer		MANITOU
1.2	Model Name		MI 70 D ST5
1.3	Power source		Diesel
1.4	Operator type		Seated
1.5	Max. capacity	Q	7000 kg
1.6	Load centre of gravity	c	600 mm
1.8	Load distance, centre of drive axle to fork	x	603 mm
1.9	Wheelbase	y	2300 mm
Weight			
2.1	Service weight		10110 kg
2.2	Weight on front axle (laden) / rear axle (laden)		15290 kg / 1820 kg
Wheels			
3.1	Tyres type		Super Elastic
3.2	Dimensions of front wheels		8.25-15 14PR
3.3	Dimensions of rear wheels		8.25-15 14PR
3.5	Number of front wheels / rear wheels		4 / 2
3.5.2	Number of drive wheels		4
3.6	Front wheel gauge	b10	1489 mm
3.7	Rear wheel gauge	b11	1700 mm
Dimensions			
4.1	Tilt of Mast Forward (deg) / Backward (deg)	α / β	6 / 12
4.7	Height of overhead guard (cabin)	h6	2430 mm
4.8	Seat height/stand height	h7	1350 mm
4.12	Height of towing bar (coupling height)	h10	710 mm
4.19	Overall length	l1	4804 mm
4.20	Length to face of forks	l2	3604 mm
4.21	Overall width	b1	1990 mm
4.22	Forks section / width / length	s / e / l	65 mm x 150 mm / 1220 mm
4.23	Fork carriage ISO 2328 (class/form) A/B		FEM 4A
4.31	Ground clearance below mast	m1	190 mm
4.32	Ground clearance at centre of wheelbase	m2	270 mm
4.34	Aisle width for 800 x 1200 pallet lengthways	Ast	5350 mm
4.36	Internal turning radius (over tyres)	b13	110 mm
Performances			
5.1	Travel speed (laden / unladen)		23 km/h / 24 km/h
5.2	Lifting speed (laden / unladen)		0.36 m/s / 0.41 m/s
5.3	Lowering speed (laden / unladen)		0.48 m/s / 0.42 m/s
5.5	Drawbar pull (Laden / Unladen)		6500 daN / 2750 daN
5.7	Gradeability (laden / unladen)		20 % / 20 %
5.10	Service brake		Hydraulic
Engine			
7.1	Engine brand / model		Deutz / TCD 3.6 L4
7.2	Engine power according to ISO 1585		55.40 kW
7.3	Rated speed		2300 rpm
7.4	Number of cylinders / Capacity of cylinders		4 - 3621 cm ³
Miscellaneous			
8.3	Oil flow rate for attachments		165 l/min
8.4	Measured/guaranteed mean noise level at the ear of the operator		< 84 dB

MI 70 D ST5 - Tekening met afmetingen

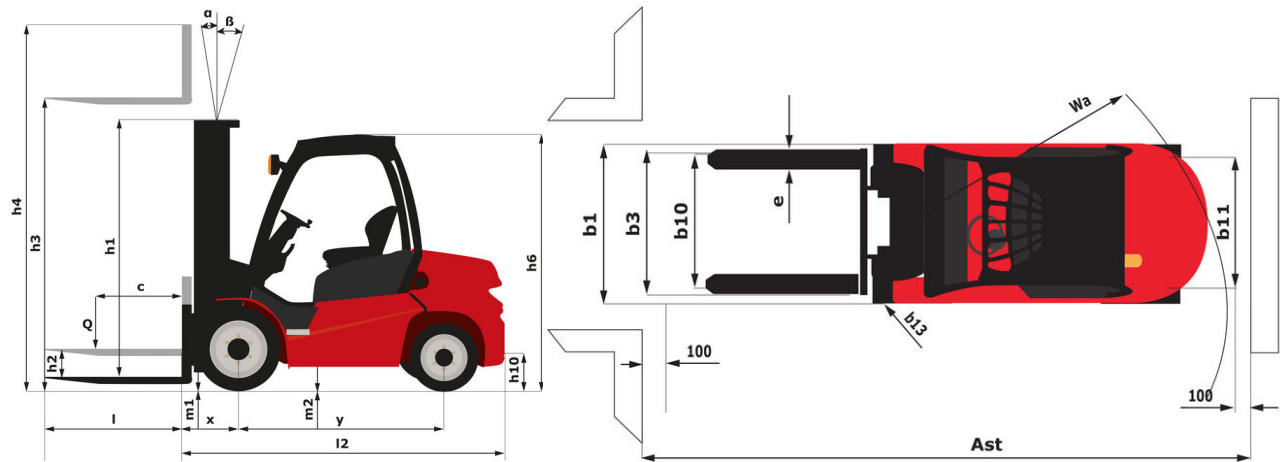

Kenmerken van de masten en restcapaciteiten

Full Visibility Duplex		FVD 30	FVD 33	FVD 36	FVD 40	FVD 45	FVD 50
h2 - Free lift	mm	160	160	160	160	160	160
h1 - Height mast lowered *	mm	2500	2650	2800	3000	3300	3550
h3 - Lifting Height	mm	3000	3300	3600	4000	4500	5000
h4 - Height mast extended *	mm	4167	4467	4767	5167	5667	6167
α / β - Mast inclination (front / rear)	°	6 / 12	6 / 12	6 / 12	6 / 12	6 / 6	6 / 6
Residual capacity without attachment (Industrial load chart)	kg	7000	7000	7000	7000	7000	7000
Residual capacity with hooked-on side shift (Industrial load chart)	kg	6500	6500	6500	6500	6500	6500
Height at max capacity	mm	3000	3300	3600	4000	4500	5000
Height at max capacity with hooked-on sideshift	mm	3000	3300	3600	4000	4500	5000

Free Lift Duplex		FLD 30	FLD 33	FLD 36	FLD 40
h2 - Free lift	mm	1335	1485	1635	1835
h1 - Height mast lowered *	mm	2450	2600	2750	2950
h3 - Lifting Height	mm	3000	3300	3600	4000
h4 - Height mast extended *	mm	4115	4415	4715	5115
α / β - Mast inclination (front / rear)	°	6 / 12	6 / 12	6 / 12	6 / 12
Residual capacity without attachment (Industrial load chart)	kg	7000	7000	7000	7000
Residual capacity with hooked-on side shift (Industrial load chart)	kg	6500	6500	6500	6500
Height at max capacity	mm	3000	3300	3600	4000
Height at max capacity with hooked-on sideshift	mm	3000	3300	3600	4000

Free Lift Triplex		FLT 45	FLT 48	FLT 50	FLT 55	FLT 60
h2 - Free lift	mm	1500	1600	1672	1800	2000
h1 - Height mast lowered *	mm	2725	2825	2875	3075	3225
h3 - Lifting Height	mm	4500	4800	5000	5500	6000
h4 - Height mast extended *	mm	5735	6035	6213	6785	7235
α / β - Mast inclination (front / rear)	°	6 / 6	6 / 6	6 / 6	3 / 6	3 / 6
Residual capacity without attachment (Industrial load chart)	kg	6400	6300	6300	6100	5500
Residual capacity with hooked-on side shift (Industrial load chart)	kg	5900	5800	5800	5600	5000
Height at max capacity	mm	4500	4800	5000	5500	6000
Height at max capacity with hooked-on sideshift	mm	4500	4800	5000	5500	6000



Siège Social

430 rue de l'Aubinière - 44150 Ancenis Cedex - France

Tel: +33(0)2 40 09 10 11 - Fax: +33 (0)2 40 09 10 97

www.manitou.com



Deze publicatie geeft een beschrijving van de versies en configuratiemogelijkheden van de Manitou-producten, waarvan de uitrusting kan verschillen. De afgebeelde uitrustingen in deze brochure kunnen standaard, optioneel of niet leverbaar zijn, afhankelijk van de versies. Manitou behoudt zich het recht voor om op te allen tijde en zonder voorafgaande kennisgeving de vermelde specificaties te wijzigen. De weergegeven specificaties zijn niet bindend voor de fabrikant. Voor meer bijzonderheden kunt u uw Manitou dealer raadplegen. Dit document is niet contractueel. De presentatie van de producten is niet contractueel. Specificatielijst is niet uitputtend. De logo's, evenals de visuele identiteit van de onderneming zijn eigendom van Manitou en mogen niet zonder toestemming worden gebruikt. Alle rechten voorbehouden. De foto's en schema's in deze brochure zijn bedoeld als informatie en zijn indicatief.

MANITOU BF NV - Naamloze vennootschap met raad van bestuur - Kapitaal: 39 668 399 euro - 857 802 508 RCS Nantes